

# FlexCore 4000

Category II or Category IV Appliance

(see Installation and Operation Manual for venting information)

## CODE OPTIONS

CSD-1	STANDARD
-------	----------

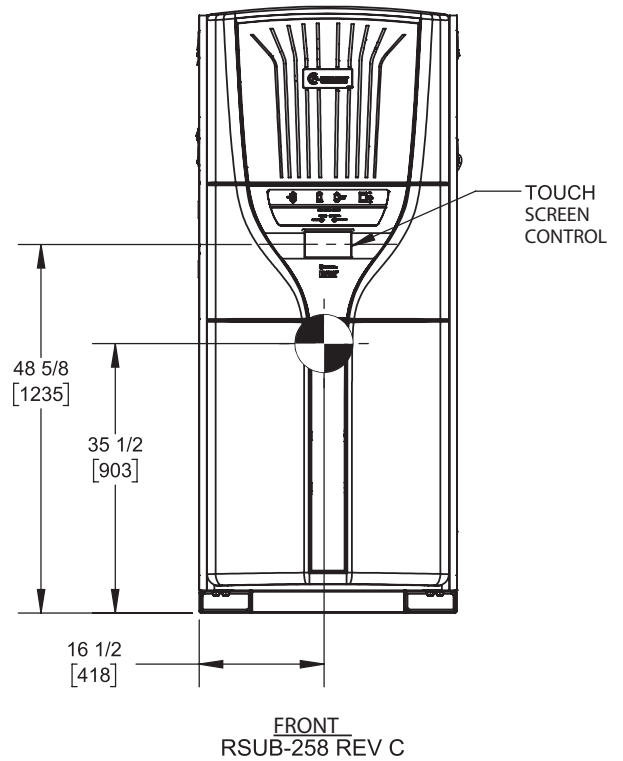
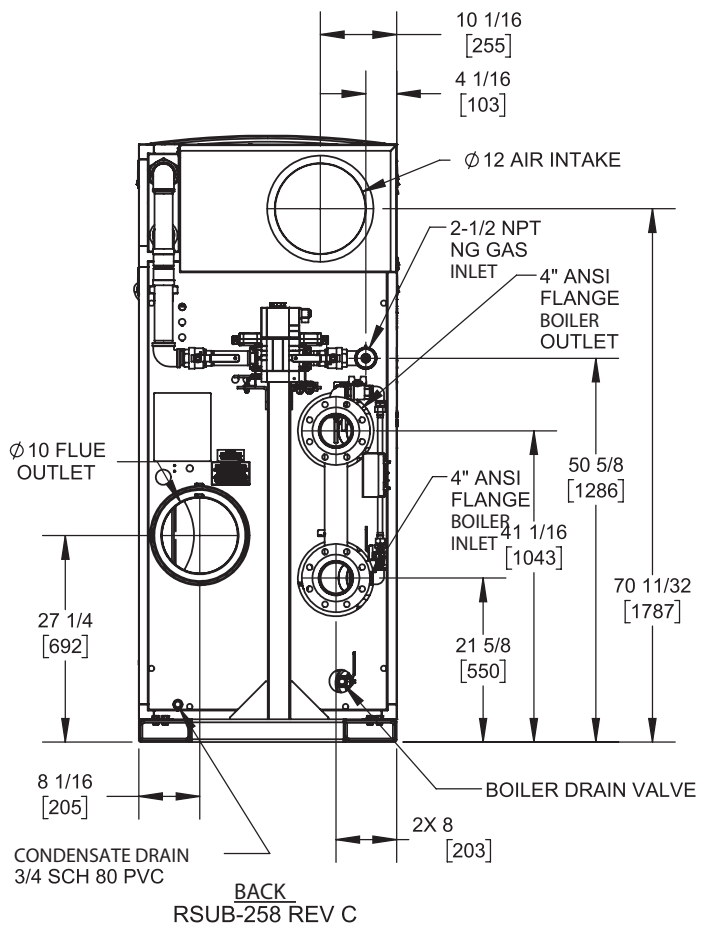

### Notes:

1. Dimensions are approximate and should not be used to "rough-in" equipment.
2. Dimensions are subject to change without notice.
3. All dimensions are in inches (mm).
4.  Symbol indicates center of gravity.

# FlexCore 4000

Category II or Category IV Appliance  
(see Installation and Operation Manual for venting information)

## CODE OPTIONS

CSD-1	STANDARD
-------	----------

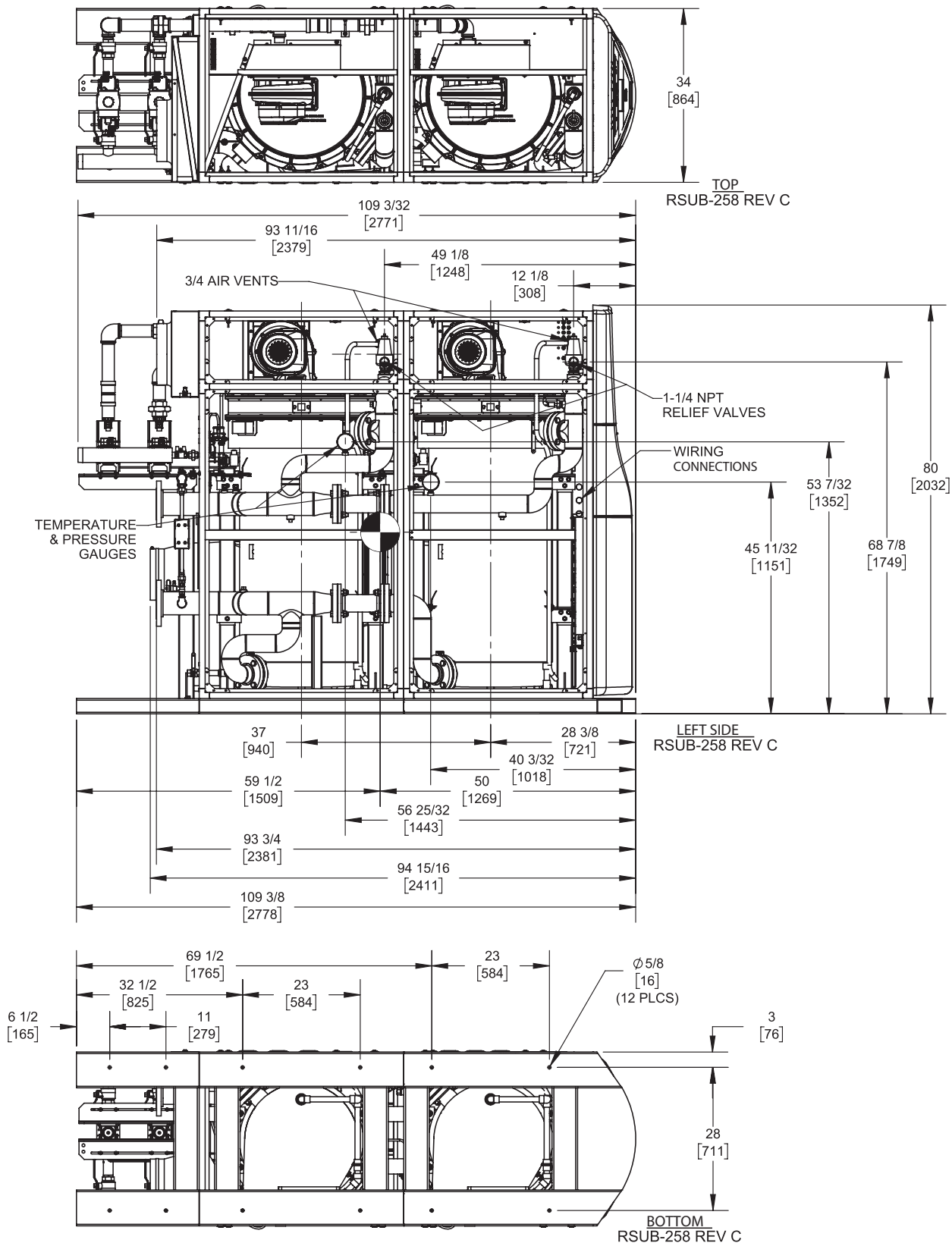

**Notes:**

1. Dimensions are approximate and should not be used to "rough-in" equipment.
2. Dimensions are subject to change without notice.
3. All dimensions are in inches (mm).
4. ● Symbol indicates center of gravity.

## BOILER CERTIFIED RATINGS & CAPACITIES

<b>Fuel Type</b>	Natural Gas	<b>Boiler FLA</b>	20.6*
<b>Input BTU/hr.</b>	3,998,000 / 1172 KW	<b>Boiler HP</b>	113.6
<b>Output BTU/hr.</b>	3,802,098 MBH / 1114 KW	<b>Min. Gas Pressure Required</b>	3" W.C.
<b>Electrical Requirements</b>	230 VAC/60 Hz/3PH	<b>Max. Gas Pressure Allowed</b>	14" W.C.
		<b>Operating Weight</b>	4580 lbs / 2077 kg

## BOILER TRIM & CONTROLS

<b>Main Gas Valve</b>	Dungs MBC	<b>Air Switch</b>	Huba
<b>Firing Valve</b>	1 1/2" Apollo	<b>Flow Sensor</b>	SIKA
<b>Ignition Control</b>	Honeywell RM7895C	<b>Blocked Flue Switch</b>	Cleveland NS2
<b>Operating Control</b>	HeatNet®	<b>Blower Motor</b>	Ametek
<b>High Limit</b>	Jumo	<b>L.W.C.O.</b>	800
<b>Main Ball Valve</b>	1 1/2" Apollo	<b>Relief Valve (2)</b>	1" x 1-1/4" set @ 50 psi
<b>Pilot Cock</b>	1/4"	<b>Pilot Regulator</b>	White-Rodgers

## A.S.M.E.

<b>ASME Sect IV Fire Side Htg Surface</b>	336 Sq. Ft. / 31.2 Sq. M.	<b>Design Data</b>	Max. 160 psig & 210°F
<b>ASME Sect IV Water Side Htg Surface</b>	348 Sq. Ft. / 32.4 Sq. M.	<b>Water Volume</b>	124 gal / 468 liters
<b>CV. GPM (1PSID)</b>	168		

\* Add circulator amps.

## BOILER TEMPERATURE RISE / PRESSURE DROP (Based on Full Input)

20°F / 11.1°C		40°F / 22.2°C				60°F / 33.3°C				80°F / 44.4°C				100°F / 55.5°C					
Flow Rate		Pressure Drop		Flow Rate		Pressure Drop		Flow Rate		Pressure Drop		Flow Rate		Pressure Drop		Flow Rate		Pressure Drop	
GPM	L/s	Ft	kPa	GPM	L/s	Ft	kPa	GPM	L/s	Ft	kPa	GPM	L/s	Ft	kPa	GPM	L/s	Ft	kPa
380.4	24.0	11.8	35.4	190.2	12.0	3.0	8.8	126.8	8.0	1.3	3.9	95.1	6.0	0.7	2.2	76.1	4.8	0.5	1.4

Flow GPM		Temp. Rise** (°F)		Vent Length (Equiv. Ft.)		Air Inlet Length (Equiv. Ft.)	
Min	Max	Min	Max	Min	Max	Min	Max
76.1	380.4	20	100	6	100	0	100

\*\* Min/Max delta t reflects boiler operation at full input. For applications requiring operation above/below these parameters please consult factory.

<b>REP FIRM</b>	_____
<b>SUBMITTED BY</b>	_____
<b>JOB NAME</b>	_____
<b>ARCHITECT</b>	_____
<b>ENGINEER</b>	_____
<b>CONTRACTOR</b>	_____
<b>DATE</b>	_____

# FlexCore 4000

**Category II or Category IV Appliance**  
(see Installation and Operation Manual for venting information)



A Division of Mestek, Inc.  
Westfield, MA 01085  
(413) 564-5515